



**41<sup>ème</sup> OLYMPIADE DES METIERS**  
**MIROITERIE ( METIER N° 56)**



**FINALE REGIONALE**  
**LYCEE LA ROQUELLE 50207 COUTANCES**

**DOSSIER FABRICATION**

**Vendredi 19 mars et**  
**Samedi 20 mars 2010**



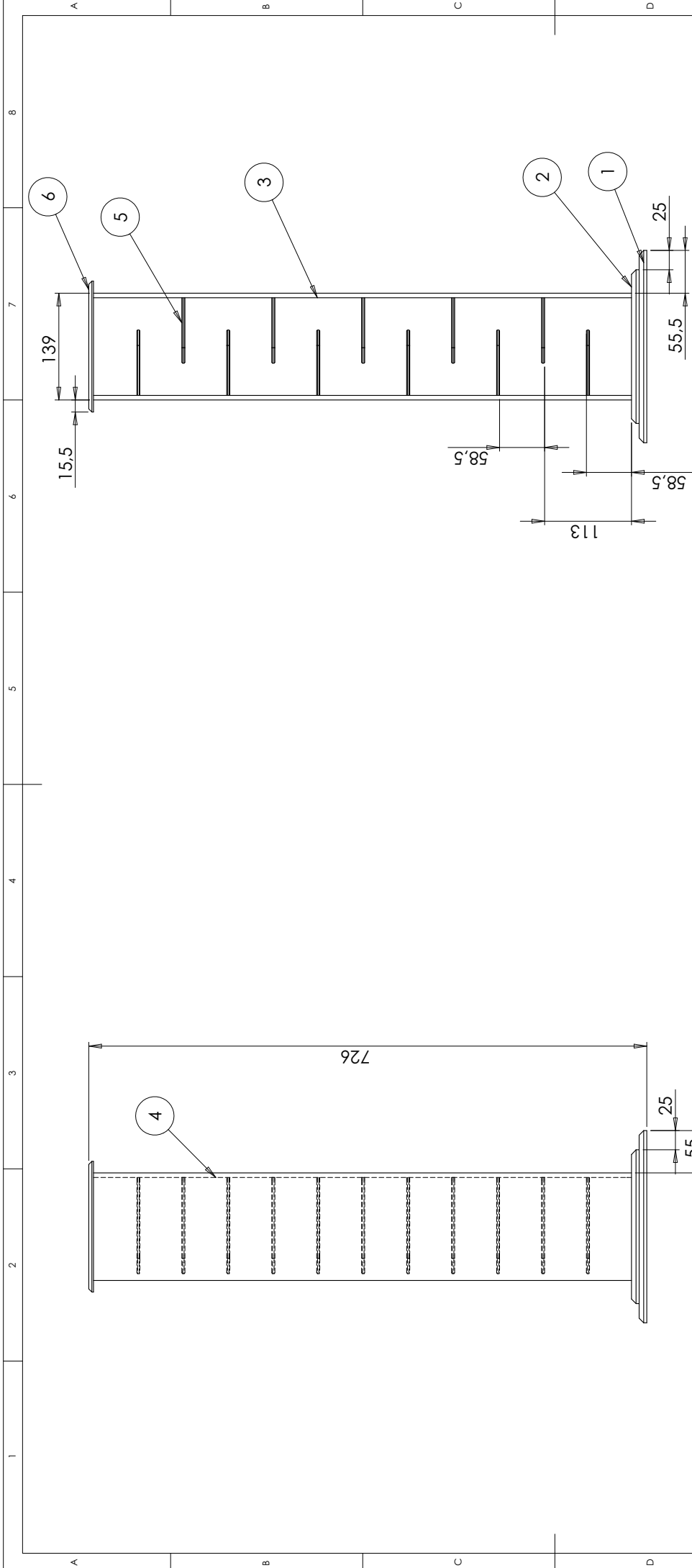

Rep	QTE	NUMERO DE PIECE	DESCRIPTION
1	1	SOCLE	verre ep 10 mm
2	1	SUR SOCLE	verre ep 10 mm
3	2	FLAN	verre ep 6 mm
4	1	FOND	verre ep 6 mm
5	11	ETAGERE	verre ep 4 mm
6	1	CHAPEAU	verre ep 6 mm

UNLESS OTHERWISE SPECIFIED: DIMENSIONS ARE IN MILLIMETERS		FINISH:		DO NOT SCALE DRAWING		REVISION	
APPROXIMATE FINISH:		DEBUR AND BREAK SHARP EDGES					
TO BE SPECIFIED:							
LINEAR:							
ANGULAR:							
NAME	SIGNATURE	DATE	TITLE:	COLONNE CD			
DRAWN							
CHKD							
APPVD							
MFG							
QA							
MATERIAL:			DWG. NO.		SCALE: 1:1		SHEET 1 OF 1
			LP LA ROQUELLE				A3

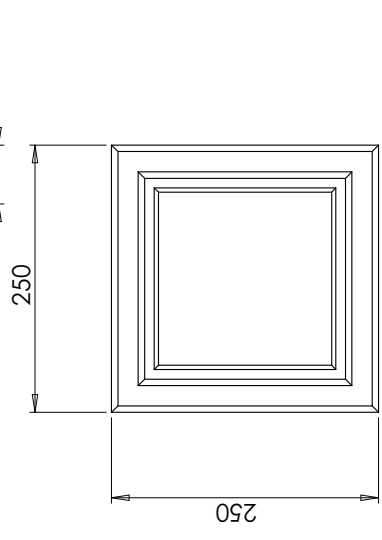
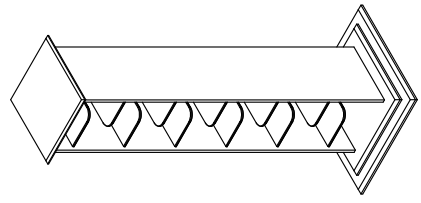

1

2

3

4

A

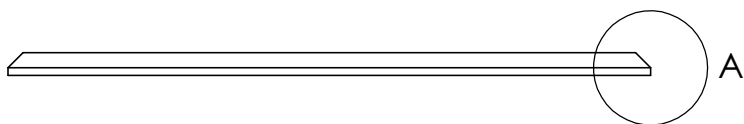

B

170

DÉTAIL A  
ECHELLE 2 : 1

C

170

D

Finition: JPP

E

Rep	QTE	Designation	DESCRIPTION
6	1	CHAPEAU	verre ep 6 mm

UNLESS OTHERWISE SPECIFIED:  
DIMENSIONS ARE IN MILLIMETERS  
SURFACE FINISH:  
TOLERANCES:  
LINEAR:  
ANGULAR:

FINISH:

DEBUR AND  
BREAK SHARP  
EDGES

DO NOT SCALE DRAWING

REVISION

F

	NAME	SIGNATURE	DATE		
DRAWN					
CHK'D					
APPV'D					
MFG					
Q.A				MATERIAL:	
				WEIGHT:	

TITLE:

verre ep 6 mm

DWG NO.

plan chapeau

A4

SCALE:1:1

SHEET 1 OF 1

1

2

3

4

A

B

C

D

E

F

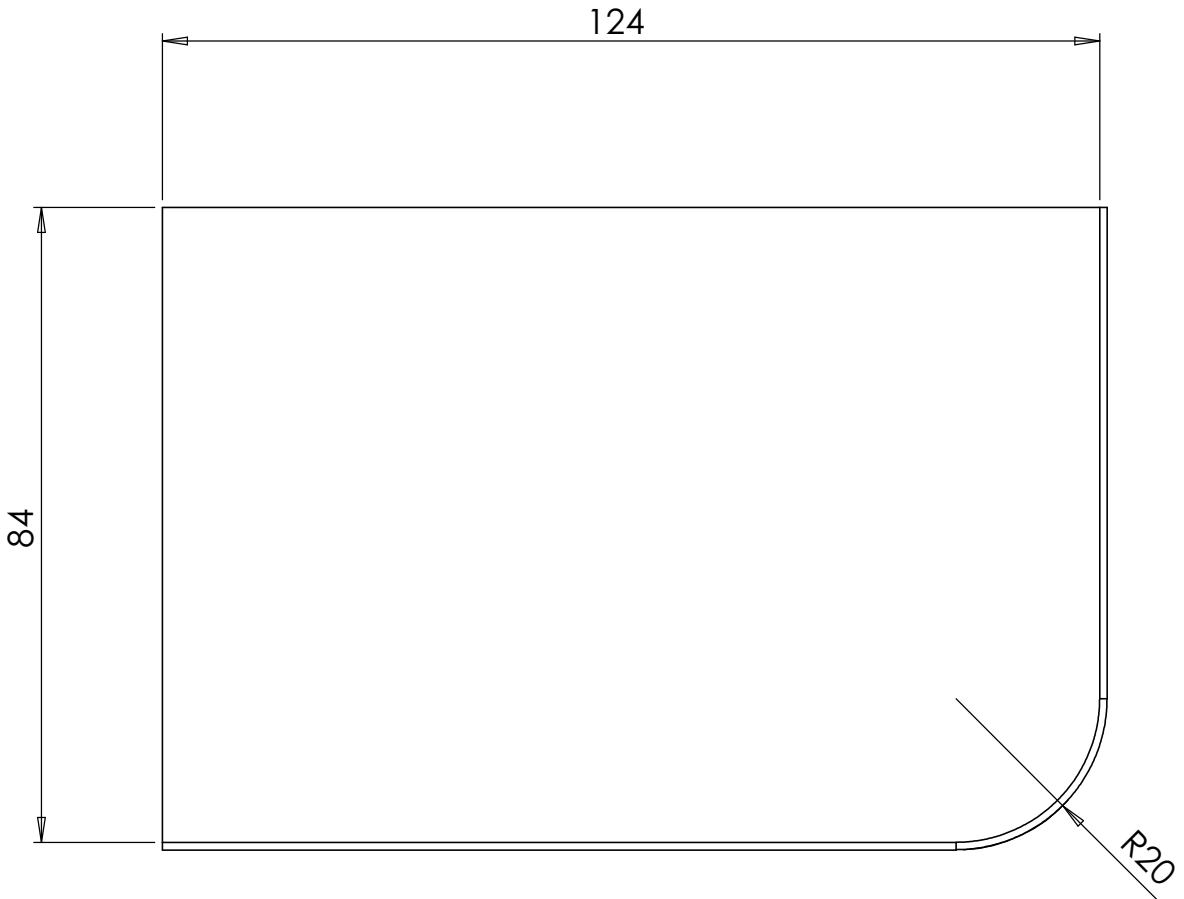

Rep	QTE	Designation	DESCRIPTION
5	11	ETAGERE	verre ep 4 mm

UNLESS OTHERWISE SPECIFIED: DIMENSIONS ARE IN MILLIMETERS SURFACE FINISH: TOLERANCES: LINEAR: ANGULAR:	FINISH:			DEBUR AND BREAK SHARP EDGES	DO NOT SCALE DRAWING	REVISION

	NAME	SIGNATURE	DATE		
DRAWN					
CHK'D					
APPV'D					
MFG					
Q.A				MATERIAL:	
				WEIGHT:	

TITLE:	verre ep 4 mm	
DWG NO.	plan etagere	A4
SCALE: 1:2	SHEET 1 OF 1	

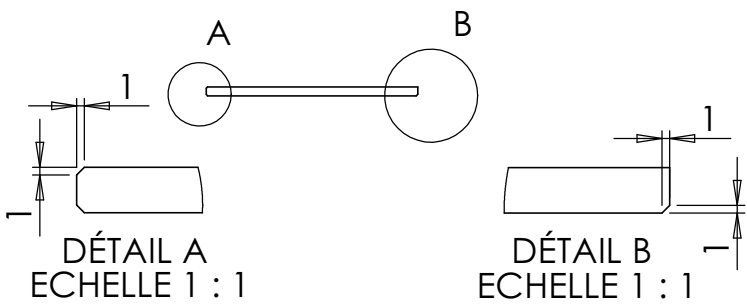
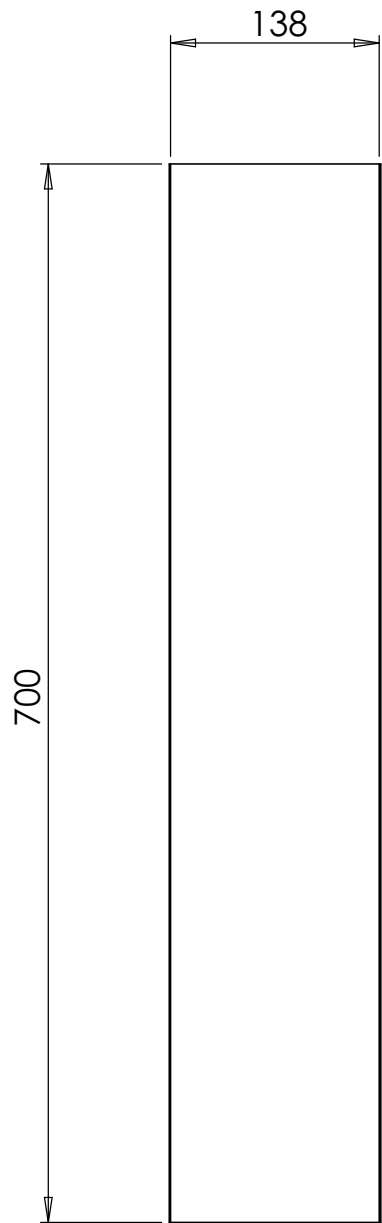

E	Rep	QTE	Designation	DESCRIPTION		
	3	2	FLAN	verre ep 6 mm		
F	UNLESS OTHERWISE SPECIFIED: DIMENSIONS ARE IN MILLIMETERS SURFACE FINISH: TOLERANCES: LINEAR: ANGULAR:		FINISH:	DEBUR AND BREAK SHARP EDGES	DO NOT SCALE DRAWING	REVISION
	NAME	SIGNATURE	DATE	TITLE:  verre ep 6 mm		
	DRAWN					
	CHK'D					
	APPV'D					
	MFG					
	Q.A			MATERIAL:	DWG NO.	plan flan
			WEIGHT:	SCALE: 1:5	SHEET 1 OF 1	

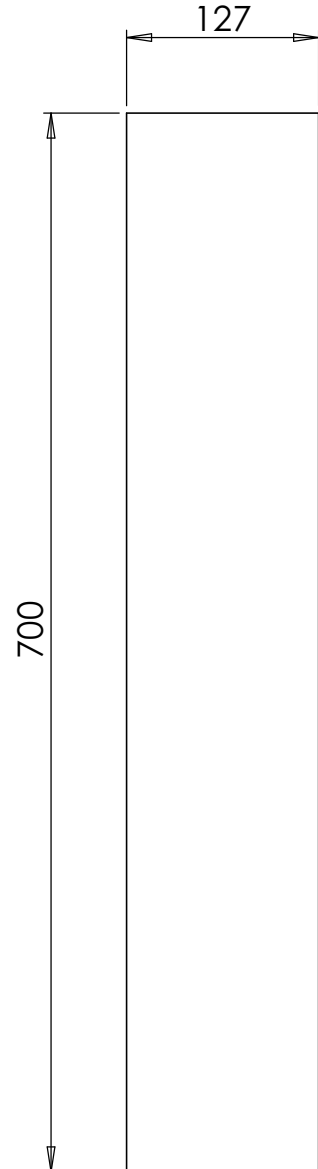

Rep	QTE	Designation	DESCRIPTION
4	1	FOND	verre ep 6 mm

UNLESS OTHERWISE SPECIFIED: DIMENSIONS ARE IN MILLIMETERS SURFACE FINISH: TOLERANCES: LINEAR: ANGULAR:	FINISH:			DEBUR AND BREAK SHARP EDGES	DO NOT SCALE DRAWING	REVISION

	NAME	SIGNATURE	DATE		
DRAWN					
CHK'D					
APPV'D					
MFG					
Q.A				MATERIAL:	
				WEIGHT:	

TITLE:		verre ep 6 mm	
DWG NO.	plan fond		A4
SCALE: 1:5	SHEET 1 OF 1		

1 2 3 4

A

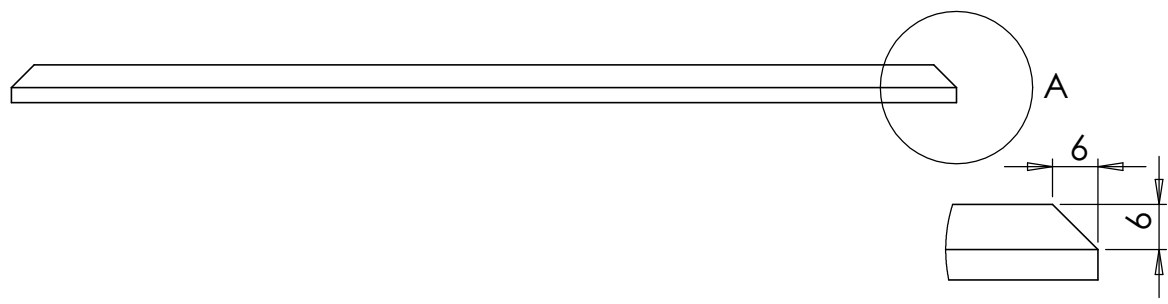

B

250

C

250

D

FINITION : J.P.P

E

Rep	QTE	Designation	DESCRIPTION
1	1	SOCLE	verre ep 10 mm

UNLESS OTHERWISE SPECIFIED: DIMENSIONS ARE IN MILLIMETERS SURFACE FINISH: TOLERANCES: LINEAR: ANGULAR:	FINISH:		DEBUR AND BREAK SHARP EDGES	DO NOT SCALE DRAWING	REVISION

F

	NAME	SIGNATURE	DATE			TITLE:  <b>verre ep 10 mm</b>
DRAWN						
CHK'D						
APPV'D						
MFG						DWG NO.  <b>plan socle</b>
Q.A				MATERIAL:		
				WEIGHT:		SCALE: 1:1
						SHEET 1 OF 1

A4

1

2

3

4

A

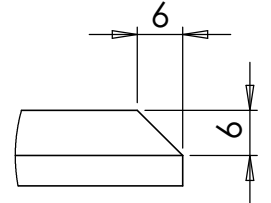
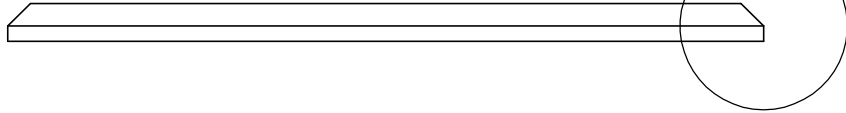

DÉTAIL A  
ECHELLE 1 : 1

B

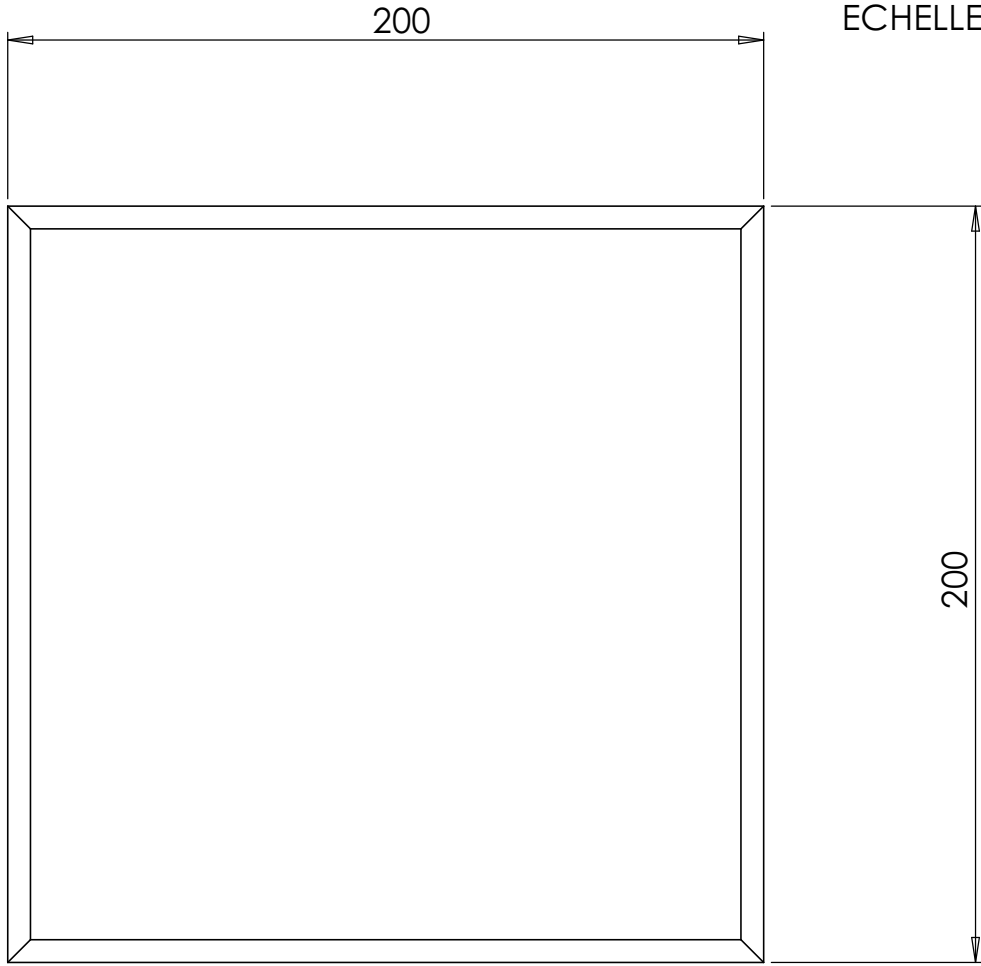

C

D

FINITION: J.P.P

E

Rep	QTE	Designation	DESCRIPTION
2	1	SUR SOCLE	verre ep 10 mm

UNLESS OTHERWISE SPECIFIED: DIMENSIONS ARE IN MILLIMETERS SURFACE FINISH: TOLERANCES: LINEAR: ANGULAR:	FINISH:			DEBUR AND BREAK SHARP EDGES	DO NOT SCALE DRAWING	REVISION

F

	NAME	SIGNATURE	DATE		TITLE:	verre ep 10 mm plan sur socle		A4
DRAWN								
CHK'D								
APPV'D								
MFG					DWG NO.			
Q.A				MATERIAL:				
				WEIGHT:	SCALE:1:2	SHEET 1 OF 1		



## BAREME DE NOTATION COLONNE CD

DESIGNATION	REP	Nom, Prénom :		
SOCLE	1			
		Cotes	250 X 250 mm	/20
		Equerrage		/20
		Façonnage		/20
SUR SOCLE	2			
		Cotes	200 X200 mm	/20
		Equerrage		/20
		Façonnage		/20
FLAN	3			
		Cotes	700 X 140 mm	/20
		Equerrage		/20
FOND	4			
		Cotes	700 X 127 mm	/20
		Equerrage		/20
ETAGERE	5			
		Cotes	84 X 124	/20
		Rayonnage	R 20	/20
		Façonnage		/20
CHAPEAU	6			
		Cotes	170 X 170 mm	/20
		Façonnage		/20
		Equerrage		/20
ASSEMBLAGE		Cote	726 mm	/20
		Cote	139 mm	/20
		Cote	15,5 mm	/20
		Cote	55,5 mm	/20
		Cote	25 mm	/20
		Cote	55 mm	/20
ASSEMBLAGE ETAGERE				
		Cote	58,5 mm	/20
		Cote	113 mm	/20
QUALITE COLLAGE UV ETAGERE				/20
QUALITE COLLAGE UV STRUCTURE				/20
ASPECT GENERAL ( rayures, coquilles, ...)				/20
PIECE FINI RESPECT DU DELAIS				/ + 10
TOTAL				/550
NON RESPECT DES REGLES DE SECURITE				/ - 3 par faute
CASSE DE PIECE				/ -5 par piece
TOTAL RECTIFIE				/550
TOTAL				/20